

# Static Bollards

Steel

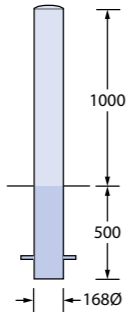

RB 101



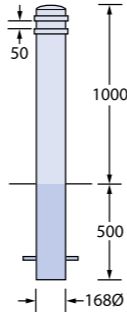

Also available ex-stock 114 x 1500

RB 105

RB 109

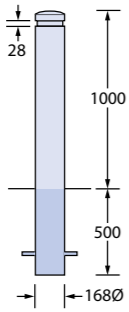
RB 111

RB 119

RB 123

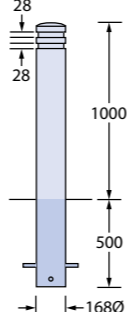
RB 150

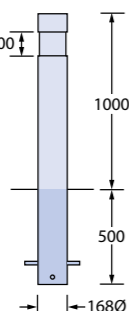
LEEDS BOLLARD

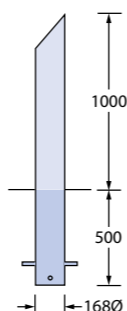
# Static Bollards

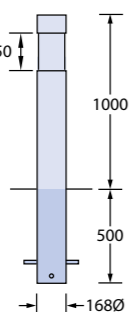
Steel

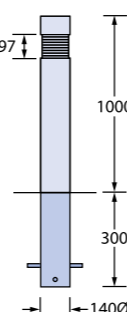

RB 119 bollards, City of Manchester Stadium

Product Description	Product Reference	Diameter (mm)	Height		Weight (kg)	Standard Finish	Options										
			Overall Height (mm)	HAG (mm)			Optional Heights		Cap		Fixing Method		Spec	Finish	Add Ons		
							Length 1250 / HAG 900 (mm)	Length 1800 / HAG 1200 (mm)	Flat Cap	Separate Cap	Base Plate	Lift Out & Lockable**			Anti Ram	Galv. Only	Hazard Banding
Semi dome top plain bollard	RB 101	114	1500	1000	20	PC Black 9005	■	■	■	■	■	■	■	■	■	■	■
	RB 101	139	1500	1000	25	PC Black 9005	■	■	■	■	■	■	■	■	■	■	■
	<b>RB 101</b>	<b>168</b>	<b>1500</b>	<b>1000</b>	<b>30</b>	<b>PC Black 9005</b>	■	■	■	■	■	■	■	■	■	■	■
Semi dome top double ring bollard	RB 105	114	1500	1000	20	PC Black 9005	■	■	■	■	■	■	■	■	■	■	■
	RB 105	139	1500	1000	25	PC Black 9005	■	■	■	■	■	■	■	■	■	■	■
	<b>RB 105</b>	<b>168</b>	<b>1500</b>	<b>1000</b>	<b>30</b>	<b>PC Black 9005</b>	■	■	■	■	■	■	■	■	■	■	■
Semi dome single indent bollard	RB 109	114	1500	1000	20	PC Black 9005	■	■	■	■	■	■	■	■	■	■	■
	RB 109	139	1500	1000	25	PC Black 9005	■	■	■	■	■	■	■	■	■	■	■
	<b>RB 109</b>	<b>168</b>	<b>1500</b>	<b>1000</b>	<b>30</b>	<b>PC Black 9005</b>	■	■	■	■	■	■	■	■	■	■	■
Semi dome double indent bollard	RB 111	114	1500	1000	20	PC Black 9005	■	■	■	■	■	■	■	■	■	■	■
	RB 111	139	1500	1000	25	PC Black 9005	■	■	■	■	■	■	■	■	■	■	■
	<b>RB 111</b>	<b>168</b>	<b>1500</b>	<b>1000</b>	<b>30</b>	<b>PC Black 9005</b>	■	■	■	■	■	■	■	■	■	■	■
Flat top large indent bollard	RB 119	114	1500	1000	20	PC Black 9005	■	■	■	■	■	■	■	■	■	■	■
	RB 119	139	1500	1000	25	PC Black 9005	■	■	■	■	■	■	■	■	■	■	■
	<b>RB 119</b>	<b>168</b>	<b>1500</b>	<b>1000</b>	<b>30</b>	<b>PC Black 9005</b>	■	■	■	■	■	■	■	■	■	■	■
Mitre top bollard	RB 123	114	1500	1000	20	PC Black 9005	■	■	■	■	■	■	■	■	■	■	■
	RB 123	139	1500	1000	25	PC Black 9005	■	■	■	■	■	■	■	■	■	■	■
	<b>RB 123</b>	<b>168</b>	<b>1500</b>	<b>1000</b>	<b>30</b>	<b>PC Black 9005</b>	■	■	■	■	■	■	■	■	■	■	■
Flat top bollard with single DDA band	RB 150	114	1500	1000	20	PC Black 9005			■	■	■	■	■	■	■	■	■
	RB 150	139	1500	1000	25	PC Black 9005			■	■	■	■	■	■	■	■	■
	<b>RB 150</b>	<b>168</b>	<b>1500</b>	<b>1000</b>	<b>30</b>	<b>PC Black 9005</b>			■	■	■	■	■	■	■	■	■
Leeds Bollard	Leeds Bollard	140	1300	1000	25	PC Grey 706					■	■	■	■	■	■	■

\*Bold text indicates standard bollard option

\*\* Lift and Lockable option available dependant on diameter